

ITEM NO.: SAMONA PE08

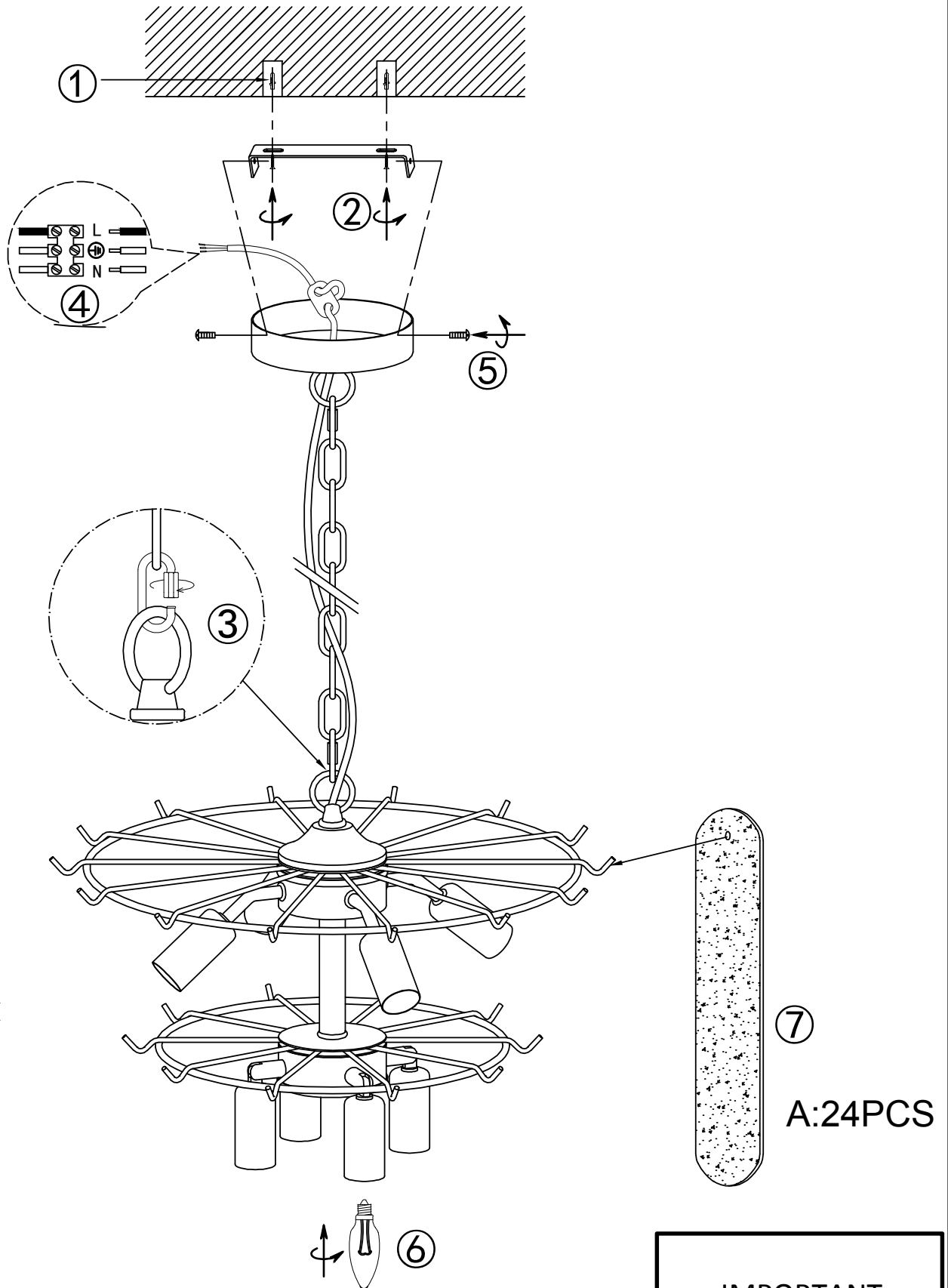

IP20

240V - 50Hz E14 Max.25Wx8

Telbix. NOTE: GLOBE NOT INCLUDED

IMPORTANT
Must be installed by
a qualified electrical
contractor.
Install in accordance
with AS/NZS3000