

# ITEM NO.: OSTROM PE65-CG

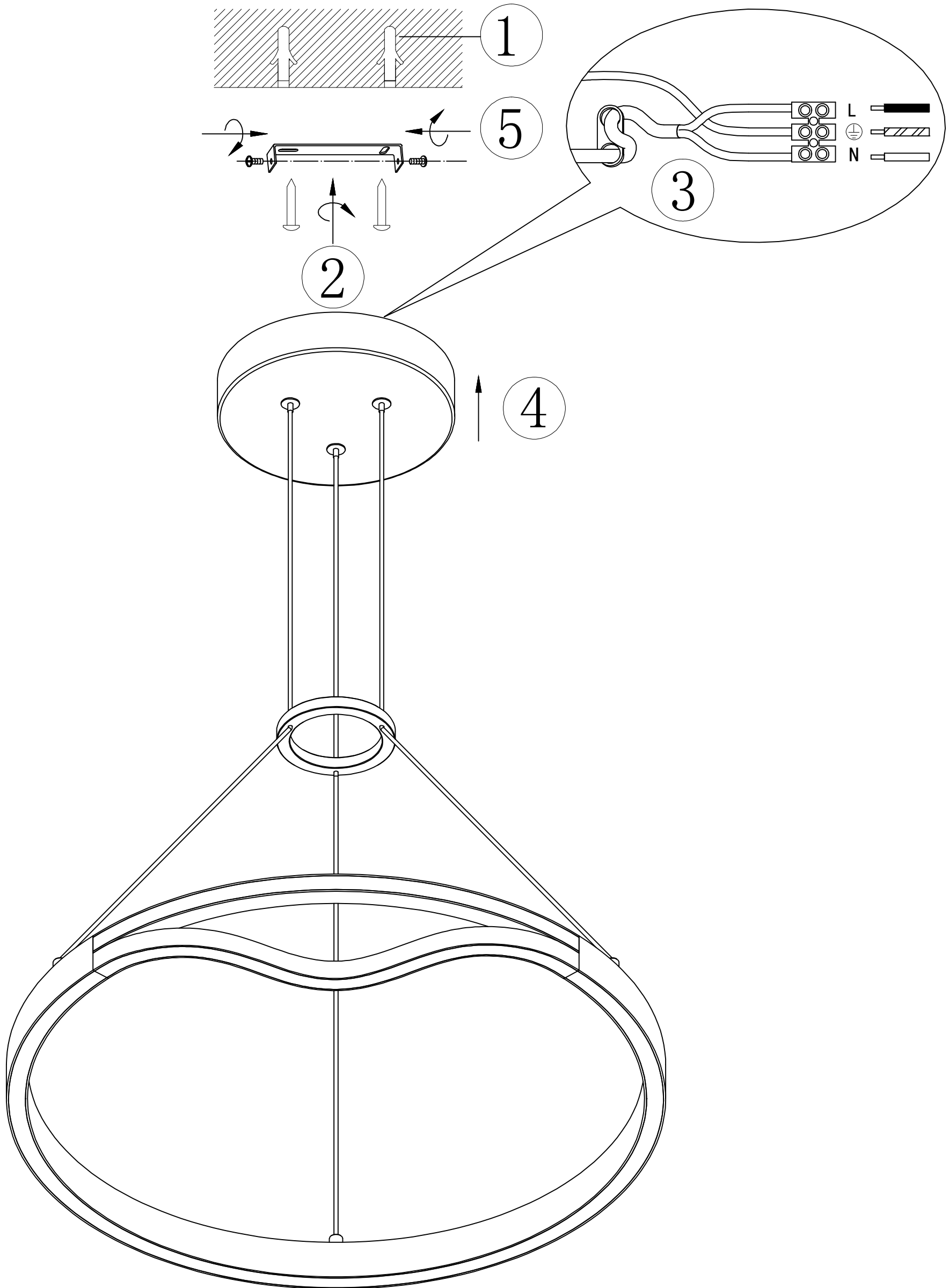

240V ~ 50Hz LED 38W 3000K  
TRAILING EDGE DIMMER

**IMPORTANT**  
Must be installed by  
a qualified electrical  
contractor.  
Install in accordance  
with AS/NSZ3000