

ITEM NO.:OSTEL EX1

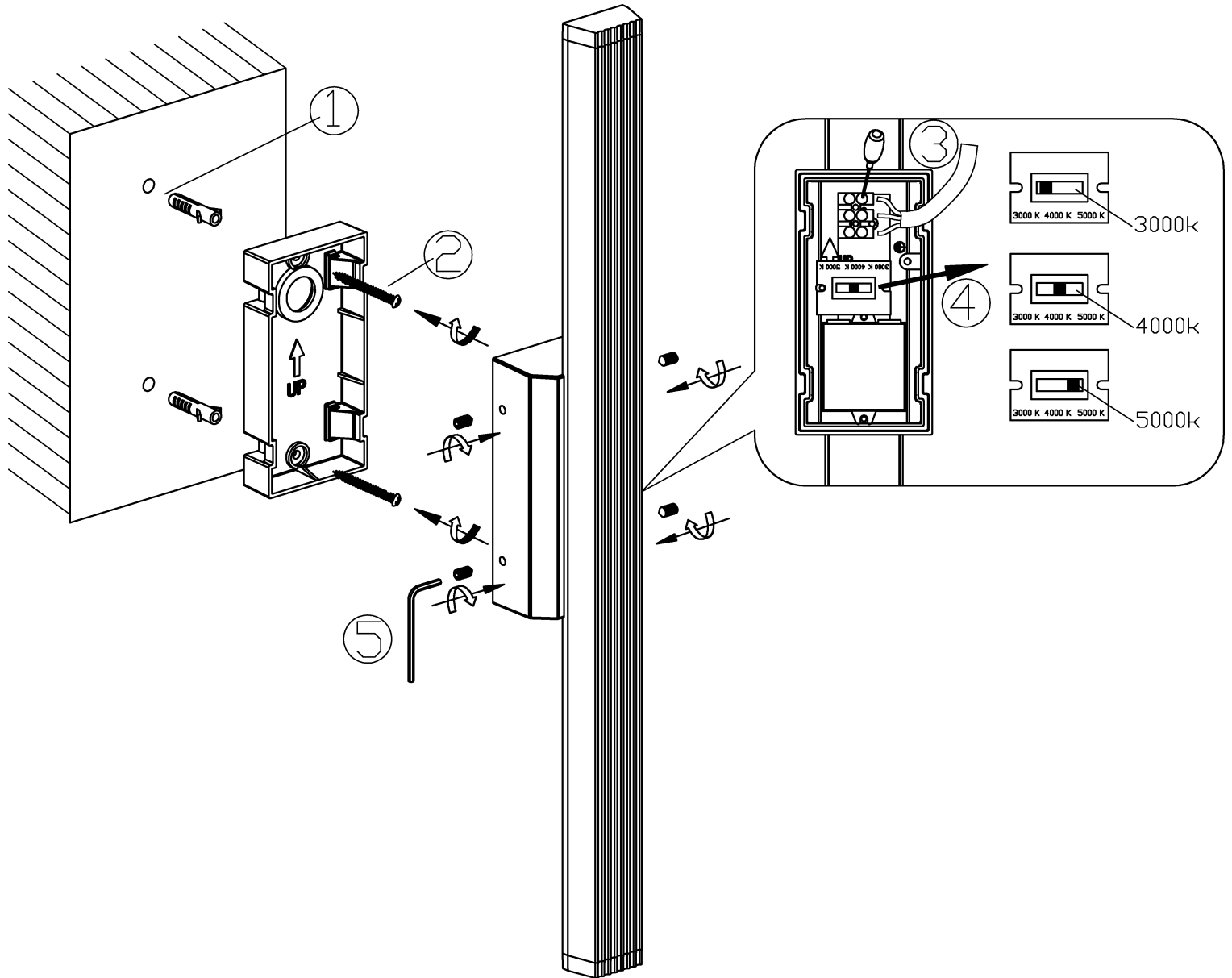

IP54

Telbix.

240V ~ 50Hz LED 14W

3000K-5000K 3CCT NON-DIM

IMPORTANT
Must be installed by
a qualified electrical
contractor.
Install in accordance
with AS/NSZ3000