

ITEM NO.: DIXON EX.2

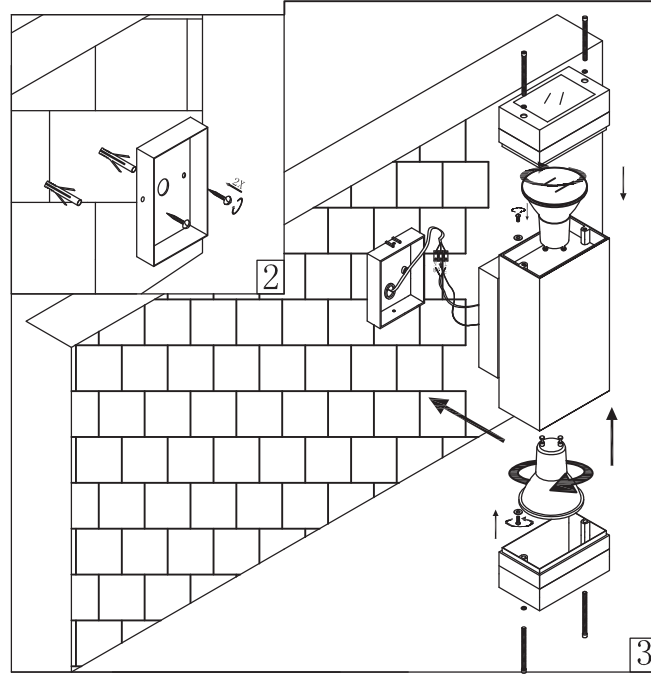

IMPORTANT
Must be installed
by a qualified
electrical contractor.
Install in accordance
with AS/NZ3000

- Disclaimer:
Tools not included
Shade ring attached on lamp holder
Globe(s) included

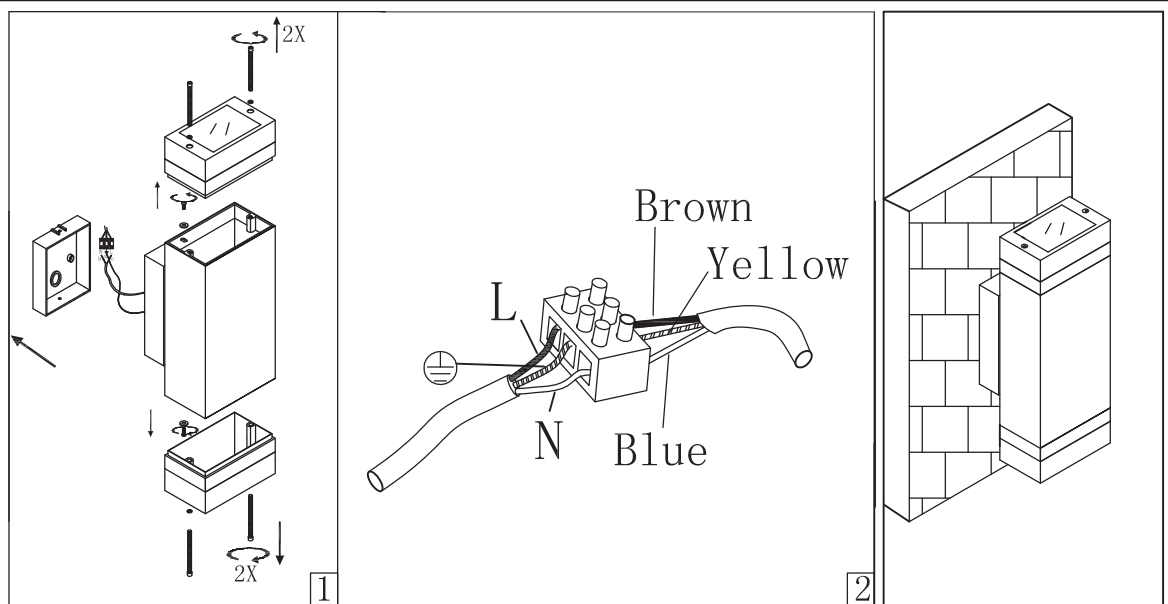

240V ~ 50Hz GU10 Max.6Wx2

NOTE: GLOBE INCLUDED

telbix.

