

ITEM NO.:AURORA PE20-RBW

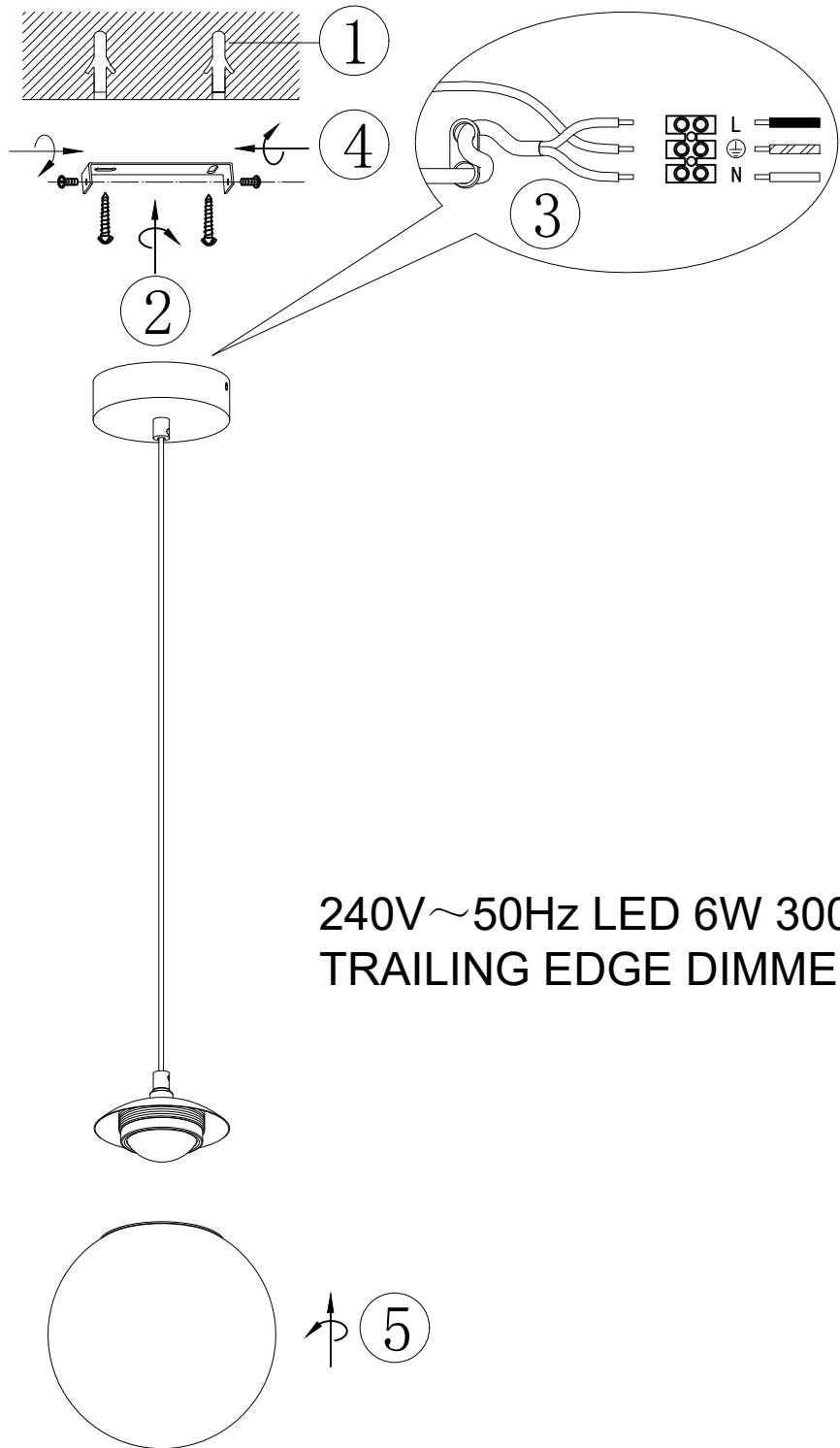

240V~50Hz LED 6W 3000K
TRAILING EDGE DIMMER

Telbix.



IMPORTANT

Must be installed by
a qualified electrical
contractor.
Install in accordance
with AS/NZS3000