

ITEM NO.: ARIVA PE80

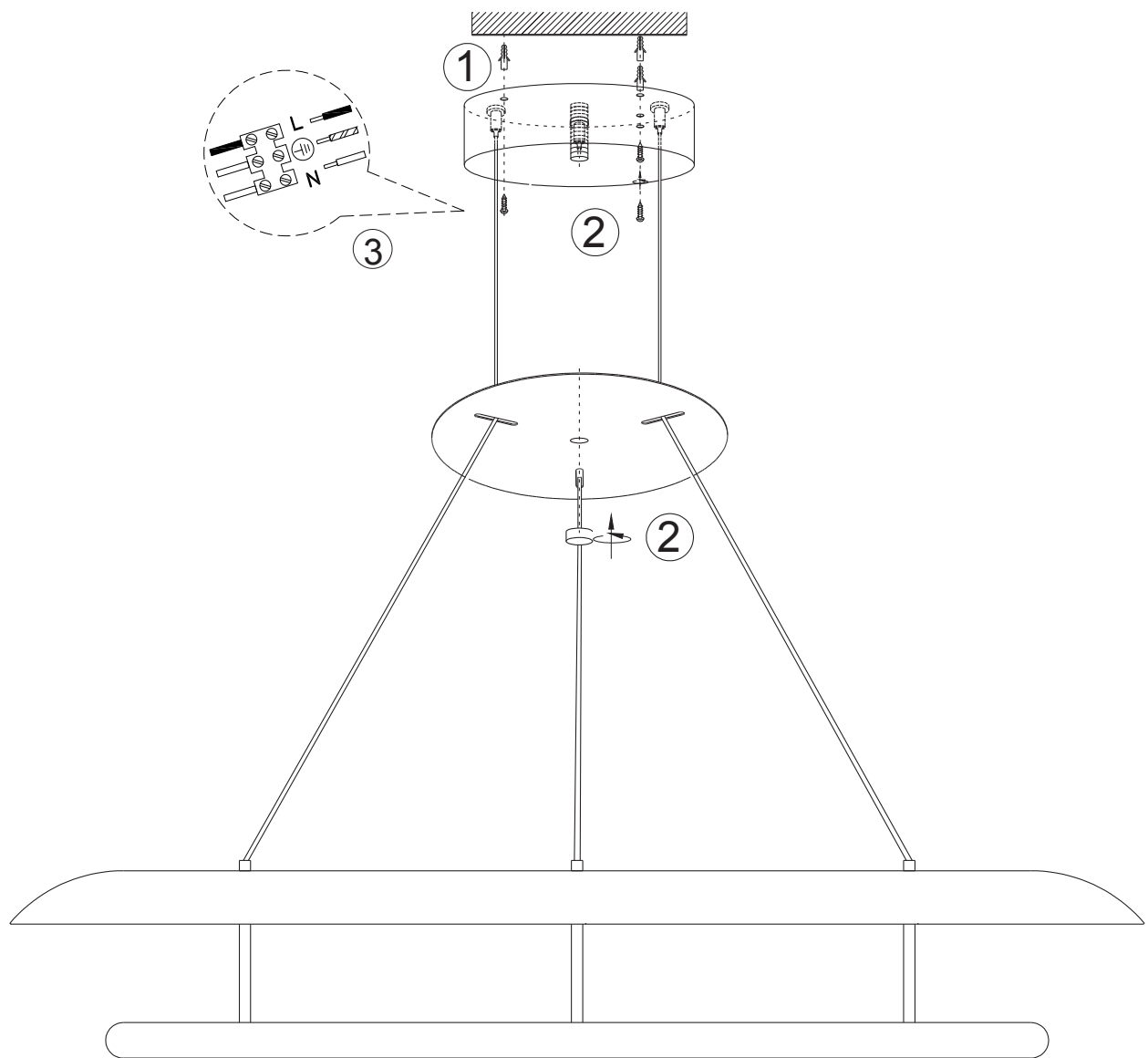

IP20

240V ~ 50Hz LED 34W

3000K-4000K-5000K

TRAILING EDGE DIMMER

**telbix.**

**IMPORTANT**

Must be installed by a qualified electrical contractor.

Install in accordance with AS/NSZ3000.